



TR-7553-CA

Transformer Protection Relays

WTIs for Oil Cooled Transformers

(1 OTI + 3 WTI)

Standard Features:

- Single unit for temperature monitoring for Top Oil temperature & Three windings of the transformer.
- Relay Outputs
Seven C/O output contacts for Oil Alarm, Oil Trip, Winding 1 Alarm, Winding 2 Alarm, Winding 3 Alarm & Winding Trip common for all three windings & Fan Control.
- Anticipated Fan Control & Auto Fan Exerciser.
- Extremely high reliability for harsh environment conditions of switchyard.
- Memorizes max. Temperature (recordings available even after power fail conditions).
- Analog signals (4-20mA) for OTI & WTI (highest temp out of three winding temperatures) for remote indication
- RS-485 communication with MODBUS RTU Slave protocol for remote indication or SCADA connectivity

TR-7553-CA is designed for safe operation of oil cooled power transformers. It is suitable for control room as well as marshalling box installation and is built for long and trouble-free operation under extreme conditions of service associated with transformer.

User can change set point that can be used to control the cooling fans, to get warning of high temperature of oil and windings and to shut down the transformer in case of excessive heating (trip).

RTD sensor allows the user to monitor the oil temperature, while the C.T. signal is used to calculate and display the winding temperature. TR-7553-CA is programmed to note and store maximum temperature attained by oil and windings. Facility extends to recall this information and to clear it for fresh recording. The maximum temperature reading is stored and saved even after the power to the controller fails.

Auto Fan Exerciser feature helps in preventing jamming of fans after no operation for long periods of time. Anticipated Fan control feature turns on the Fan much before the actual winding temperature reaches the fan set point resulting in better thermal management for the transformer.

General Specifications

- Sensor Inputs: 3 wire Pt-100 (Cl. B, IEC-60751) for measuring top oil temperatures.
- Current Inputs: 3 CTs, full load secondary current of 1 to 5A, 50/60 Hz, VA capacity > 5VA for winding temp. simulation.
- Temperature indication range:
 Oil Temp.: -40 to 150 °C
 Winding Temp.: -40 to 200 °C
- Resolution: 1 °C.
- Accuracy:
 Oil temp.: ±2 °C (including RTD sensor accuracy, if sensor S-07 is used)
 Windings: ± 2 °C (excluding C.T. accuracy)
- Maximum recording: In steps of 2 °C (only temps. above 60 °C are saved)
- 4-20ma outputs: ± 1 °C (w.r.t local indication)

Displays and Indications

- 3 digits (0.5") each for oil and winding temperatures
- 1 LED to indicate displays are showing Max. Temp.
- 6 LEDs to indicate OIL alarm, OIL Trip, Sensor healthiness (Fault), Winding Alarm, Winding Trip, Fan status
- 4 LEDs to indicate Programming mode, Max Reset being processed, Fan On because of Auto Fan Exerciser or has been manually turned on.

Parameters:

- Full load CT current (settable from 1 to 5 A), individually for all windings
- dT (top oil to winding hot spot temp. gradient individually for all windings (settable from 1 to 50 °C)
- Thermal Time Constant: (settable from 1 to 60 mins)
- Oil Alarm & Trip setpoints (settable from 1 to 150 °C)
- Winding Alarm & Trip setpoints individually for all windings (settable from 1 to 200 °C)
- Fan On & Off setpoints (settable from 5 to 200 °C)
- Dead band (factory set): 4 °C
- Time delay in relay operation: approx. 4 Secs

Contact outputs (1C/O for)

- Oil Alarm
- Oil Trip
- Winding - 1 Alarm
- Winding - 2 Alarm
- Winding - 3 Alarm
- Winding Trip (common for all 3 windings)
- Cooling Fan control

Mechanical Specifications

- Overall Dim: 290(H) x 340(W) x 100(D) mm
- Mounting: Wall mounting by 4 x M6 screws
- Weight: 6.0 Kg. approx. unpacked.
- Enclosure: M.S. Sheet Box, powder coated, IP-52 protection, suitable for marshalling box installation.

Electrical Specifications

- Supply Voltage: 90-270VAC/DC (Optionally 20-50VAC/DC)
- Terminals: Screw-cage, suitable for one 2.5 mm² wire.
- Contact ratings: for res. load 10A @ 250VAC, 0.3A @ 220 VDC
- 4-20mA signals: linearity: 1%, max. load 300 ohms.
- Comm port: 1KVDC Isolated RS-485 with MODDBUS RTU Slave Protocol.
- Power consumption: Max. 20VA
- Insulation: 100 Mohm or more at 500 VDC between Earth and terminals. 2KV rms at 50 / 60 Hz for 1 minute (port to port).

Environment

- Ambient: -20 to 70 °C. R.H.: 95% max non -condensing.
- Storage Temp.: -20 to 85 °C.
- Test Conditions: Amb. Temp. 27 ±5 °C.
- Shock: 15g, Half sine, in 3 orthogonal planes

Terminal Diagrams

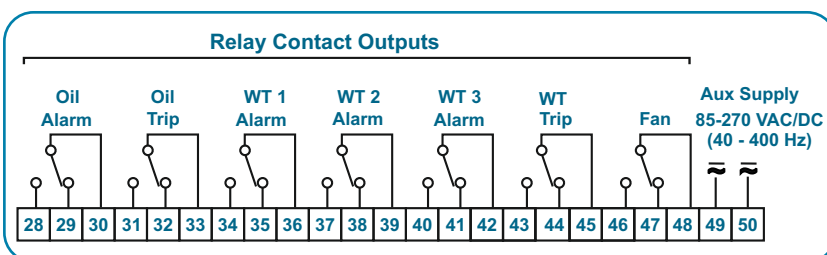
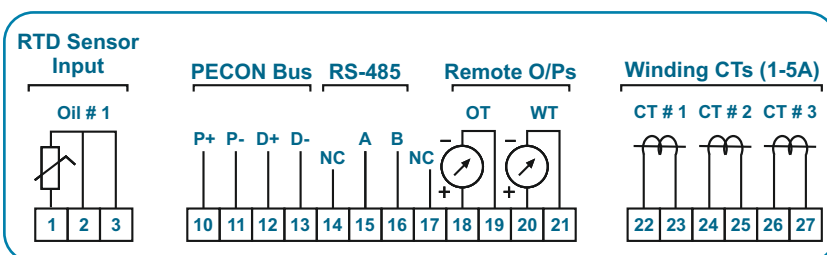

RTD sensor S-07

Salient features & Specifications:

- Suitable for all our OTI & WTI.
- 3 wire, Pt-100 type sensor (IEC-60751, Class B).
- Temperature range : – 50 to 200 °C.
- Mounting :
Male & Female BSP
(Other threads are available on demand).
- Available in duplex style (S-07MD & S-07FD) also.
- Dielectric strength : 2K VAC rms, 50 / 60 Hz for 1 min.

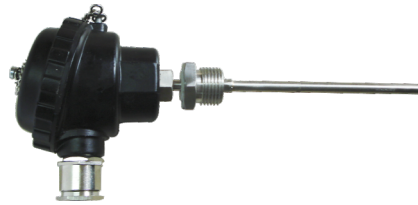

S-07M / S-07MD

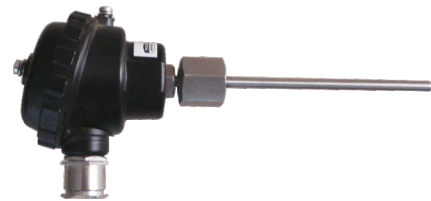

S-07F / S-07FD

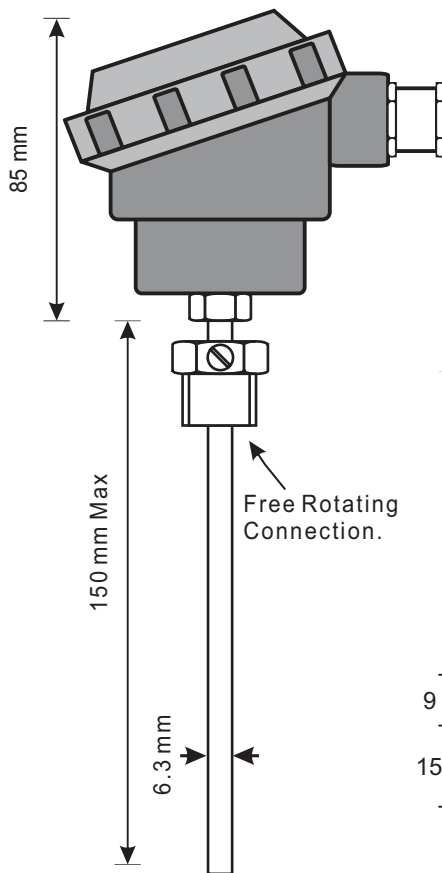

Material :
Head - Cast Aluminum
Weather Proof Head
Tube - SS 304

Terminals

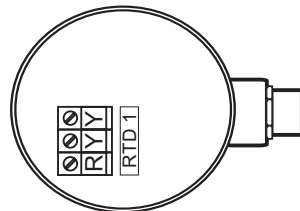

Simplex
S-07M / S-07F

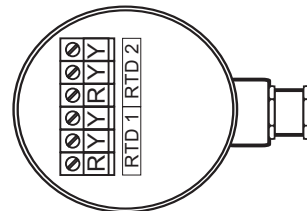

Duplex
S-07MD / S-07MF

Mounting Connection

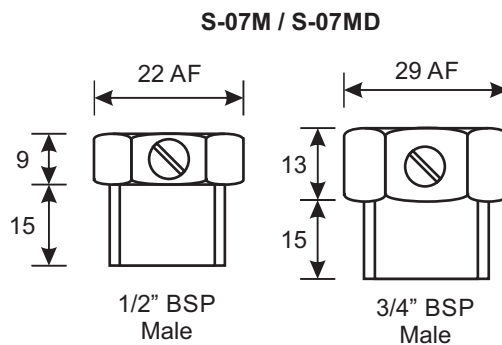

All Dimensions are in mm



**Power Electronics
& Control,
Ahmedabad**

Title		Details of RTD sensor type S-07MS & S-07MD.			
Drwn. by	MPM	Drg. No.	16022001		
Chk. by	MBA	Rev. No.	00	Rev. Date	20th Feb, 2016